

TLP 2824 Parts Catalog

View 1

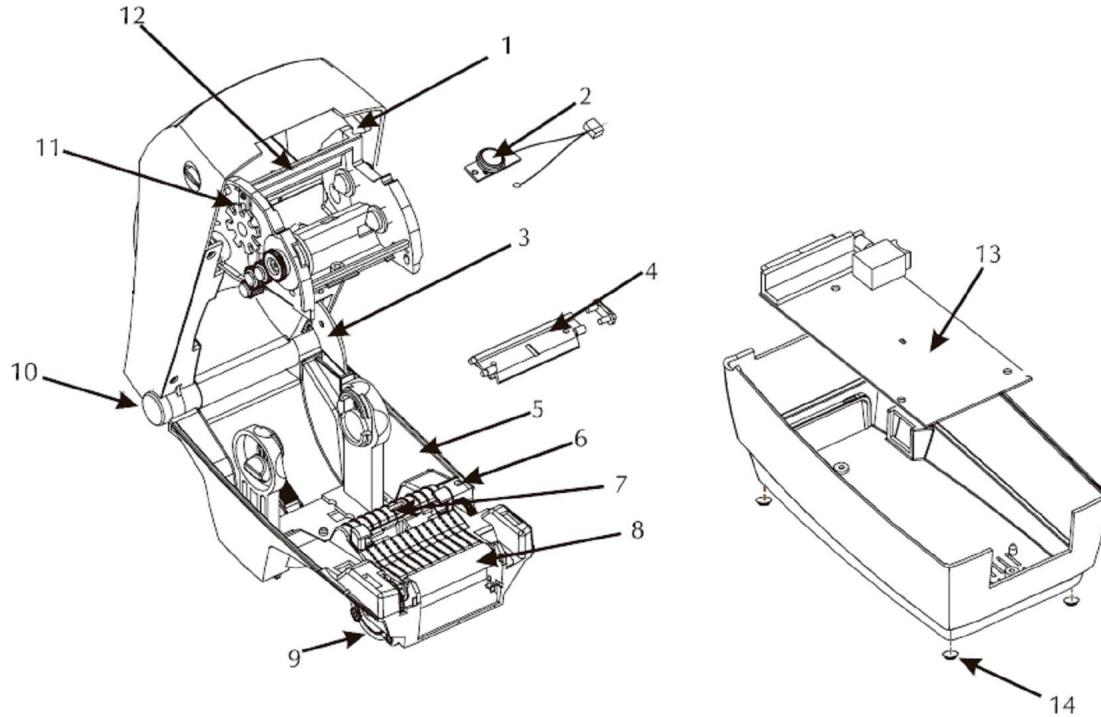

Item Number	Description	Part Number	Kit Quantity
1	Latch Assy.	G105910-146	1
2	Feed Switch / Sensor Assy.	G105910-064	3
3	Upper Cover Support	G105910-147	3
4	Printhead Assy., (203 dpi)	G105910-148	1
5	Lower Frame Assy. w/o Platen	G105910-149	1
6	Head Up Sensor	G105910-072	1
7	Gap / Blackline Sensor PCBA	G105910-054	3
8	Platen Kit, std.	105910-150	3
9	Motor, Assy.	G105910-051	2
10	Cover Hinge	G105910-180	10
11	Upper Cover Assy.	G105910-151	1
12	Ribbon Out Sensor	G105910-067	3
13	Main Control PCBA, std. Ser./USB	G105910-138	1
13	Main Control PCBA, std. Par.	G105910-139	1
13	Main Control PCBA, std. Ser./Ethernet	G105910-140	1
13	Main Control PCBA, Asian Ser./USB/Cutter	G105910-141	1
13	Main Control PCBA, Asian Par./Cutter	G105910-142	1
13	Main Control PCBA, Asian Ser./Cutter/Ethernet	G105910-143	1
13	Kit, Ethernet IO PCBA with cables	G105910-121	1
13	Kit, PrintServerII Daughter Board	G105910-123	1
13	Real Time Clock / Date I.C.	G105950-026	1
13	Real Time Clock / Date PCBA	G105910-144	1
14	Rubber Foot Kit	105910-007	24

**TLP 2824 Parts Catalog**

Item Number	Description	Part Number	Kit Quantity
	Power Supply, 100V-240V (C5) with US & Euro Cords (200dpi)	105950-060	1
	Power Supply, 100V-240V (C5) with UK & EUR Cords (200dpi)	105950-076	1
	Power Cord, U.S. 120V, IEC320C5	105950-061	5
	Power Cord, Euro 220V, IEC320C5	105950-062	5
	Power Cord, U.K. 240V, IEC320C5	105950-063	5
	Power Cord, Australia 240V, IEC320C5	105950-064	5
	Power Cord, China 220V, IEC320C5	105950-065	5
	Power Cord, Argentina 220V, IEC320C5	105950-066	5
	Power Cord, Japan 125V, IEC320C5	105950-077	5
	Ribbon Carriage w/o Printhead	G105910-152	1
	Front Bezel	105910-165	3
	Dispenser Option	G105910-118	1
	Cutter Replacement Kit	G105910-153	1
	Ribbon Core, 2 thermal transfer	105910-174	50
	Shipping Pack	105910-173	1
	CD-ROM, EPL Desktop Printers Software & Documentation	105950-028	1
	CD-ROM, Service Documentation	105950-051	1